

A

B

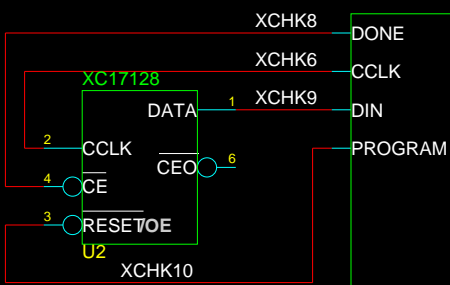

digiocc

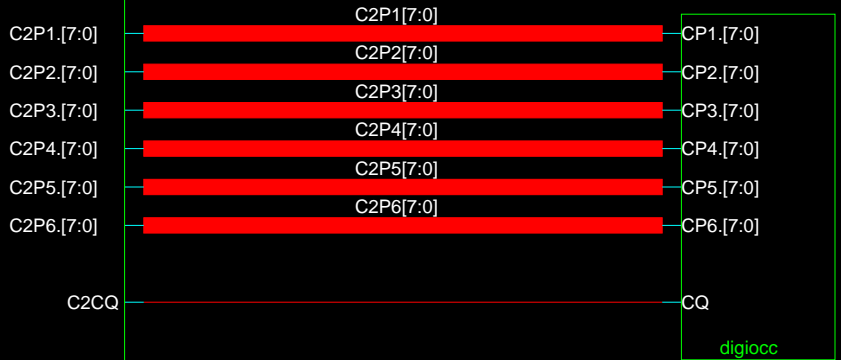
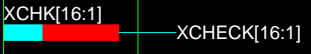
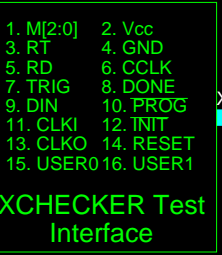

digiocc

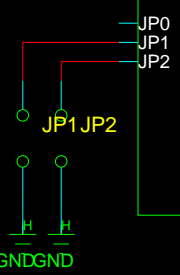
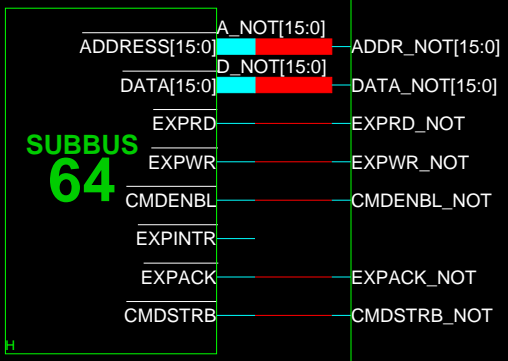

digbdxx

HARVARD UNIVERSITY
ATMOSPHERIC RESEARCH PROJECT

PREPARED		TITLE	
CHECKED		digi64 board	
ENGINEER eil		size Code ID No. Drawing No. rev	
ASHEET		A	
4-20-2005_16:20		Scale sheet 1 of 1	

A

B

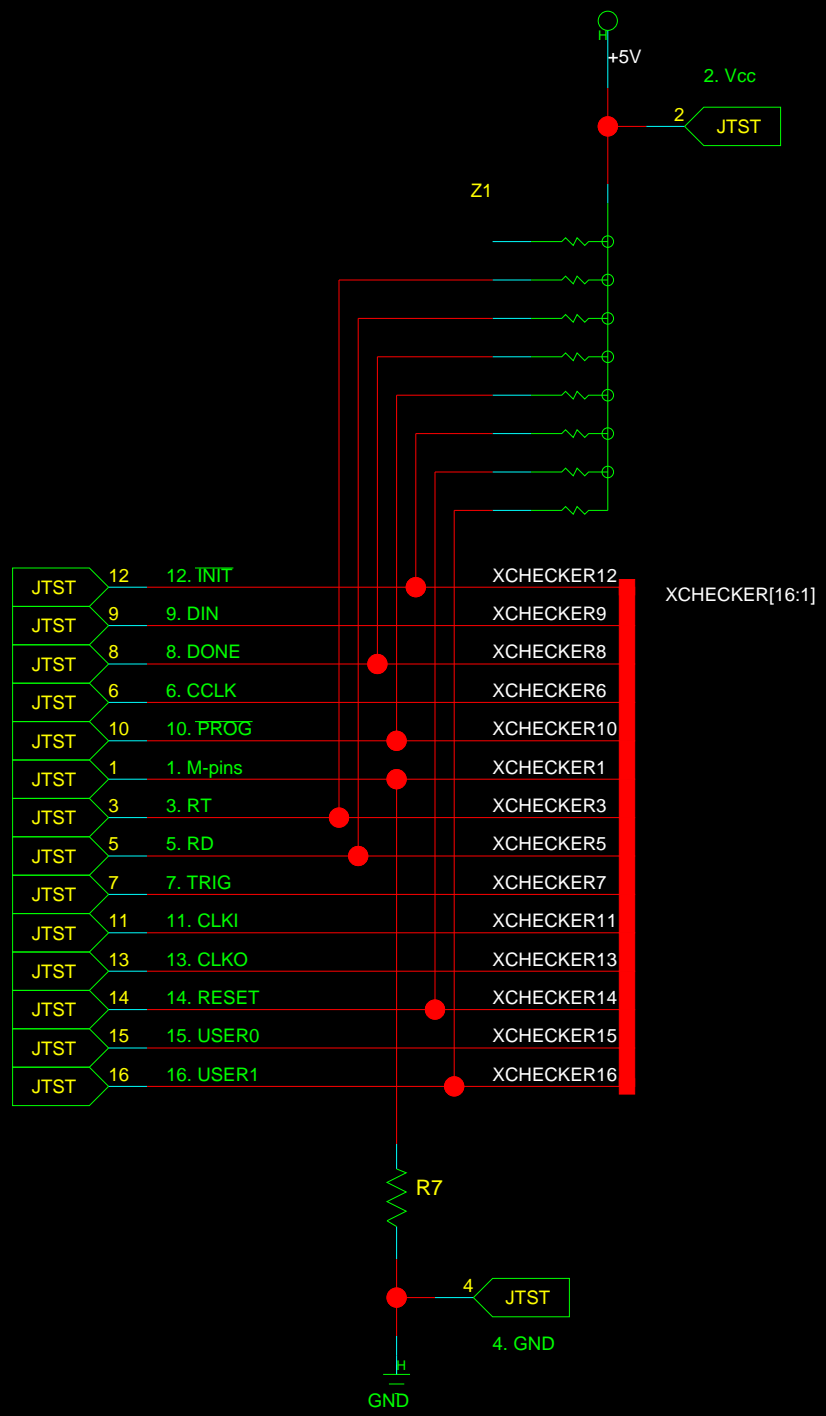

HARVARD UNIVERSITY
ATMOSPHERIC RESEARCH PROJECT

TITLE
XCHECKER Test Interface
Connector Definition

PREPARED	MR	
CHECKED		
ENGINEER	MR	

XCHECKER
 1-18-2006 05:38:20

size	Code ID No.	Drawing No.	rev
A			A
Scale	NO	sheet	1 of 1

A

B

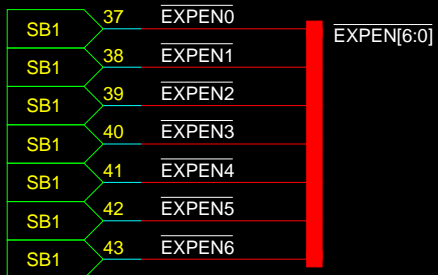
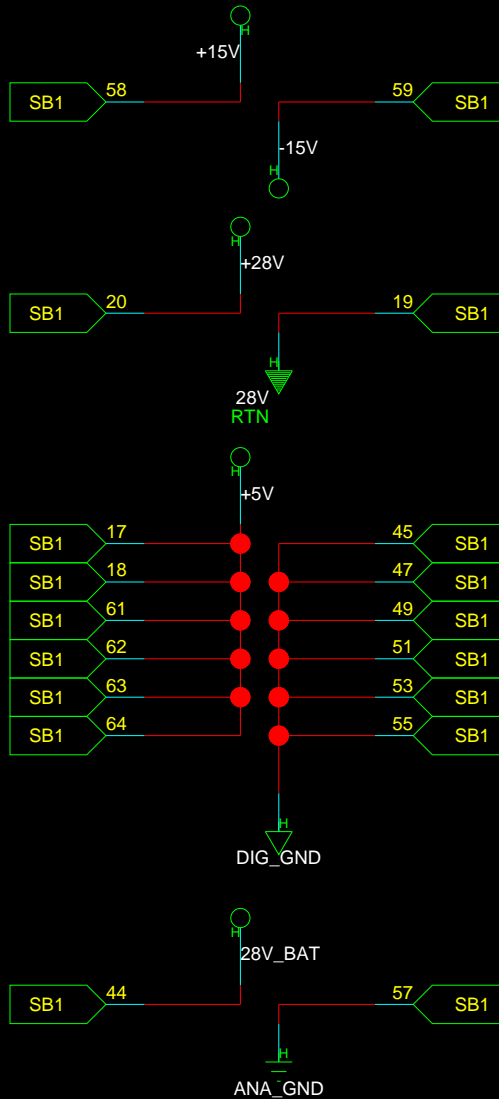
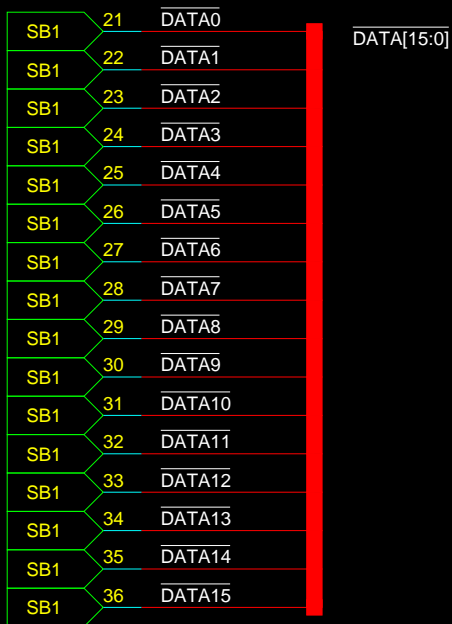
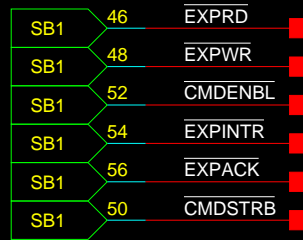
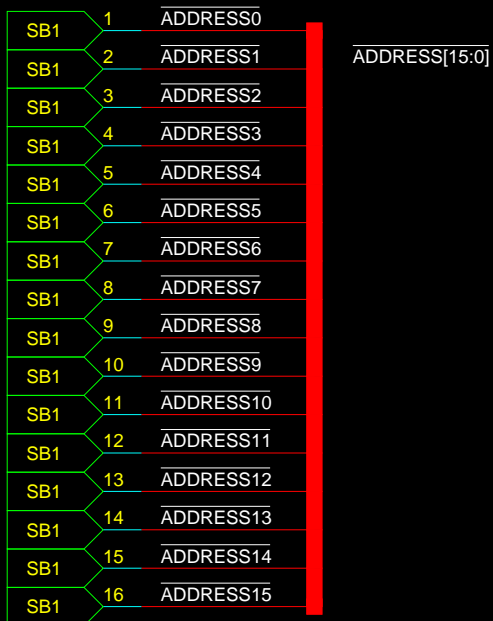

HARVARD UNIVERSITY
ATMOSPHERIC RESEARCH PROJECT

PREPARED			MR		TITLE		
CHECKED					SUBBUS Connector Definition		
ENGINEER			MR		size	Code ID No.	Drawing No.
ASHEET					A		
4-20-2005_16:20					Scale		sheet 1 of 1

A

B

rev A

Revisions				
Zone	ltr	Description	Date	Approved

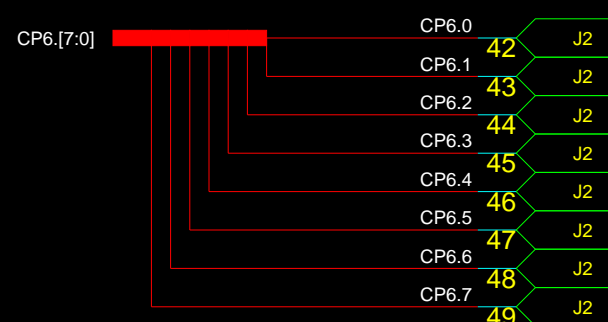
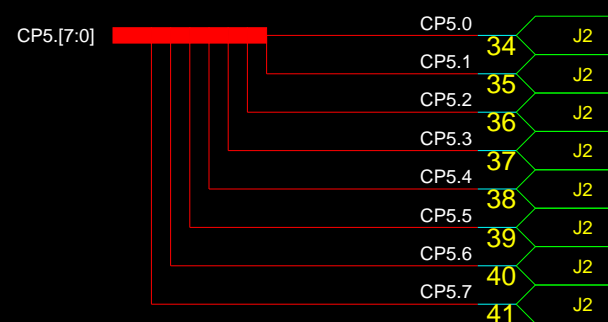
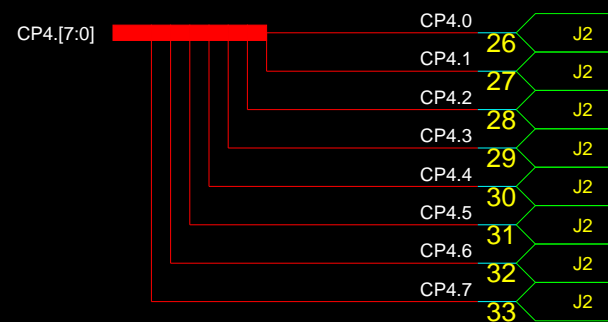
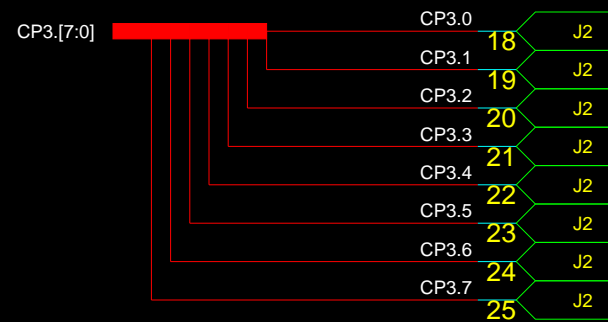
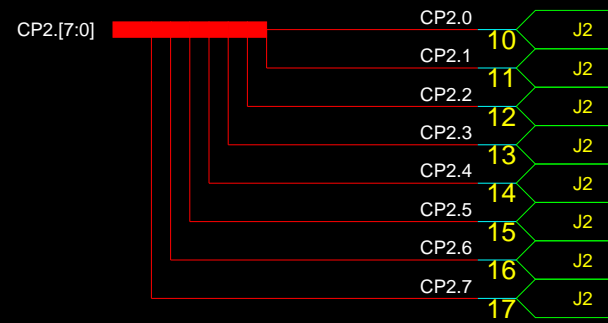
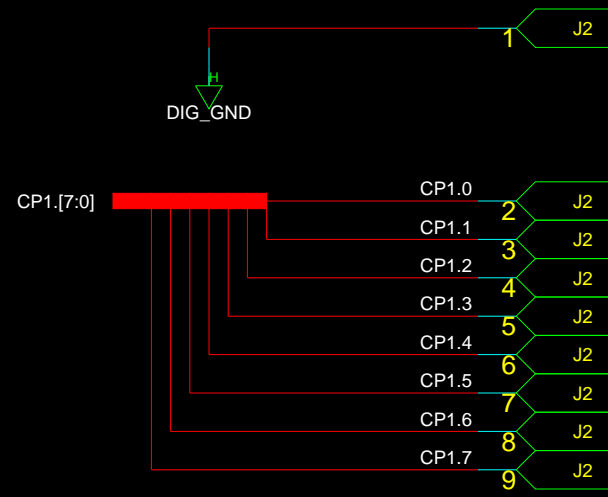

PREPARED				HARVARD UNIVERSITY ATMOSPHERIC RESEARCH PROJECT TITLE digiocc			
CHECKED							
ENGINEER		eil					
CSHEET				size	Code ID No.	Drawing No.	rev
2-24-2004_14:14				C			A
Scale				sheet 1 of 1			

Revisions				
Zone	Itr	Description	Date	Approved

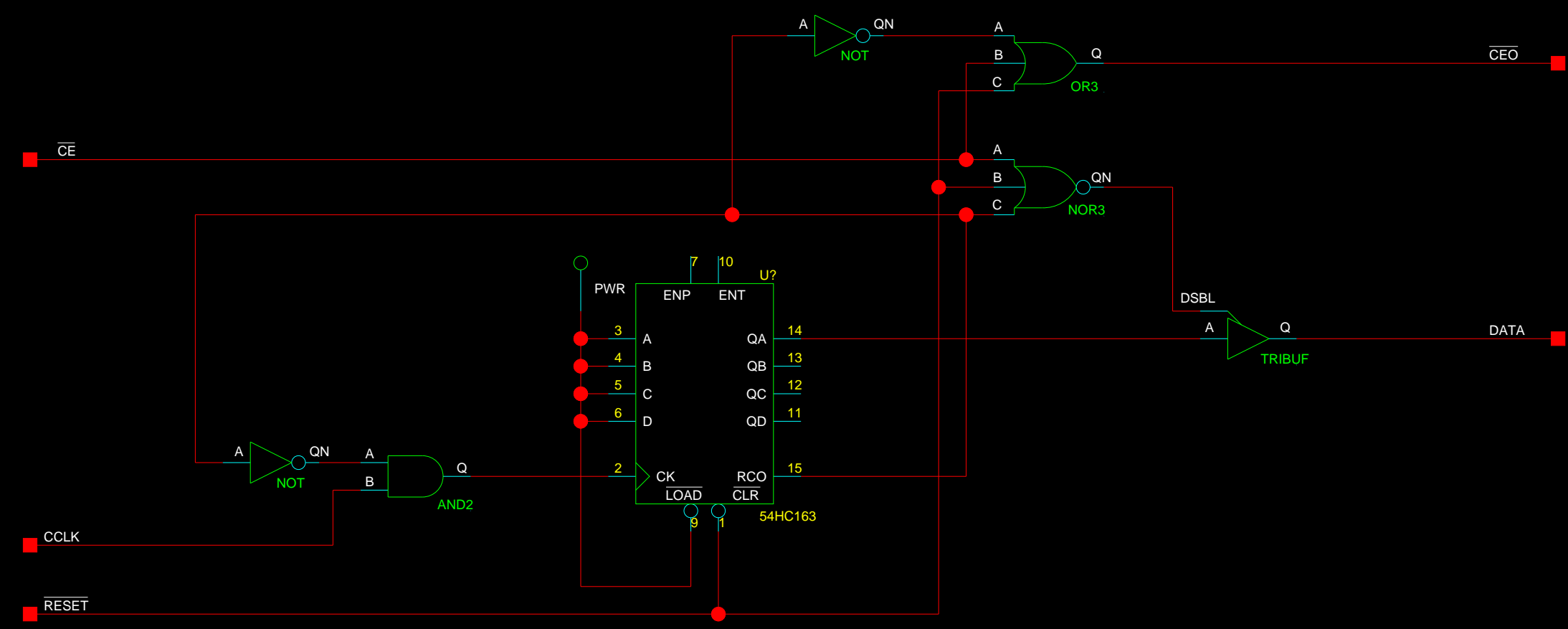

HARVARD UNIVERSITY
ATMOSPHERIC RESEARCH PROJECT

TITLE
 Mock XC17128
 For simulation Purposes Only

PREPARED	MR	
CHECKED		
ENGINEER		

BSHEET

10-2-2002_11:40

size	Code ID No.	Drawing No.	rev
B			A
Scale			sheet 1 of 1

Revisions				
Zone	ltr	Description	Date	Approved

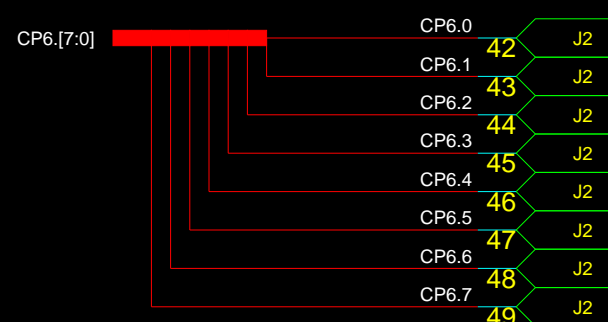
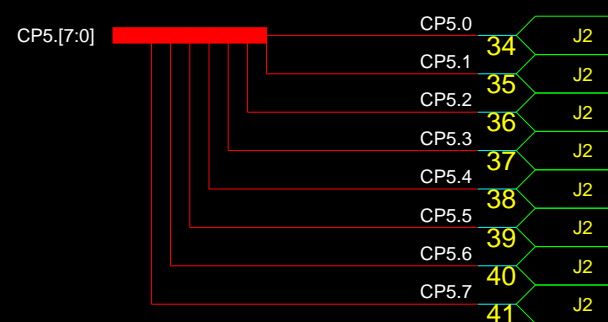
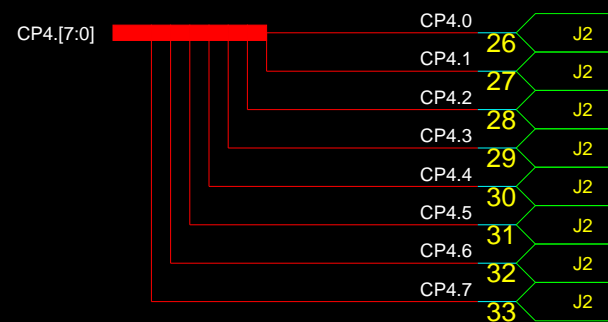
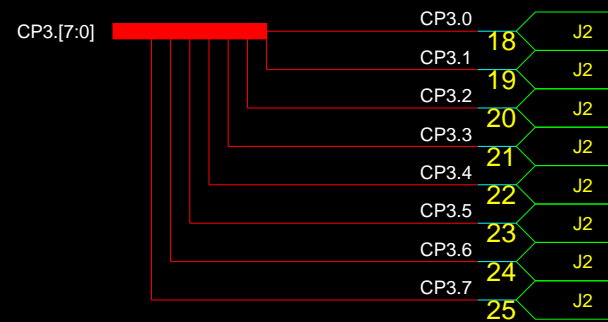
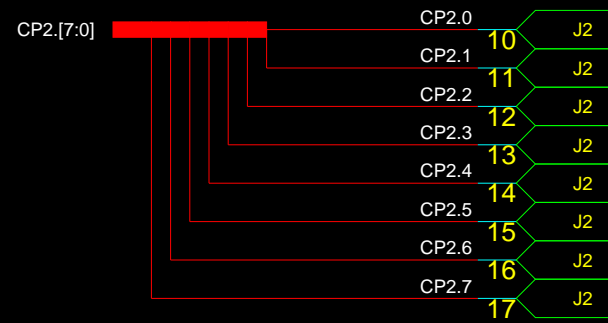
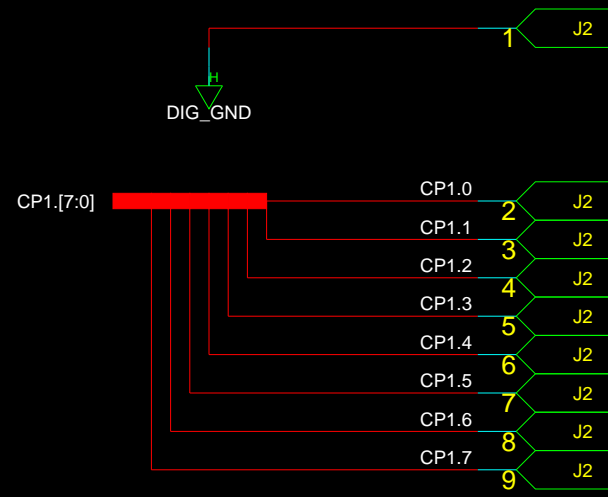

PREPARED				HARVARD UNIVERSITY ATMOSPHERIC RESEARCH PROJECT TITLE digiocc			
CHECKED							
ENGINEER		ell					
CSHEET				size	Code ID No.	Drawing No.	rev
2-24-2004_14:14				C			A
Scale				sheet 1 of 1			

Revisions			
Zone	ltr	Description	Approved

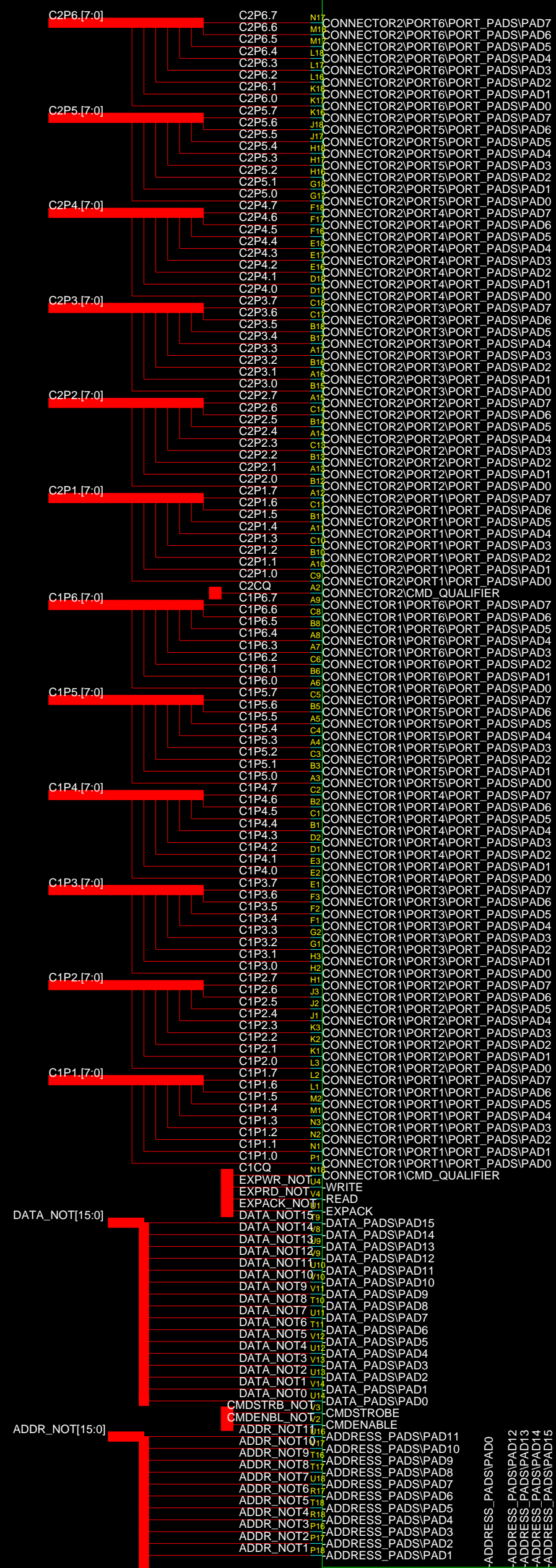
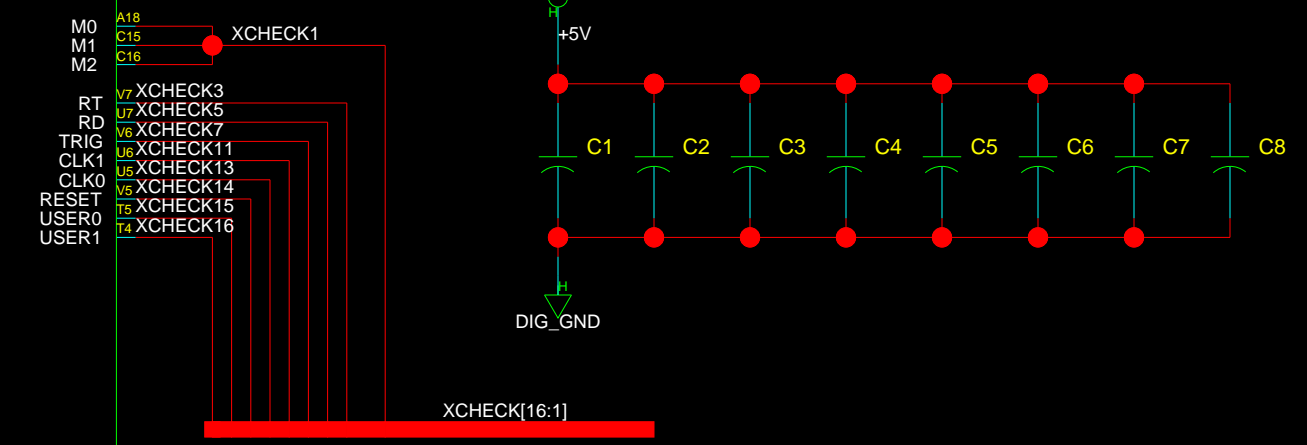
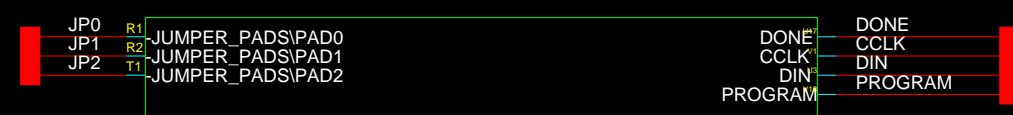

HARVARD UNIVERSITY
ATMOSPHERIC RESEARCH PROJECT

TITLE

digbdxx

PREPARED				
CHECKED				
ENGINEER	ell			

CSHEET

2-24-2004_14:14

size	Code ID No.	Drawing No.	rev
C			A

Scale sheet 1 of 1

Revisions			
Zone	ltr	Description	Approved

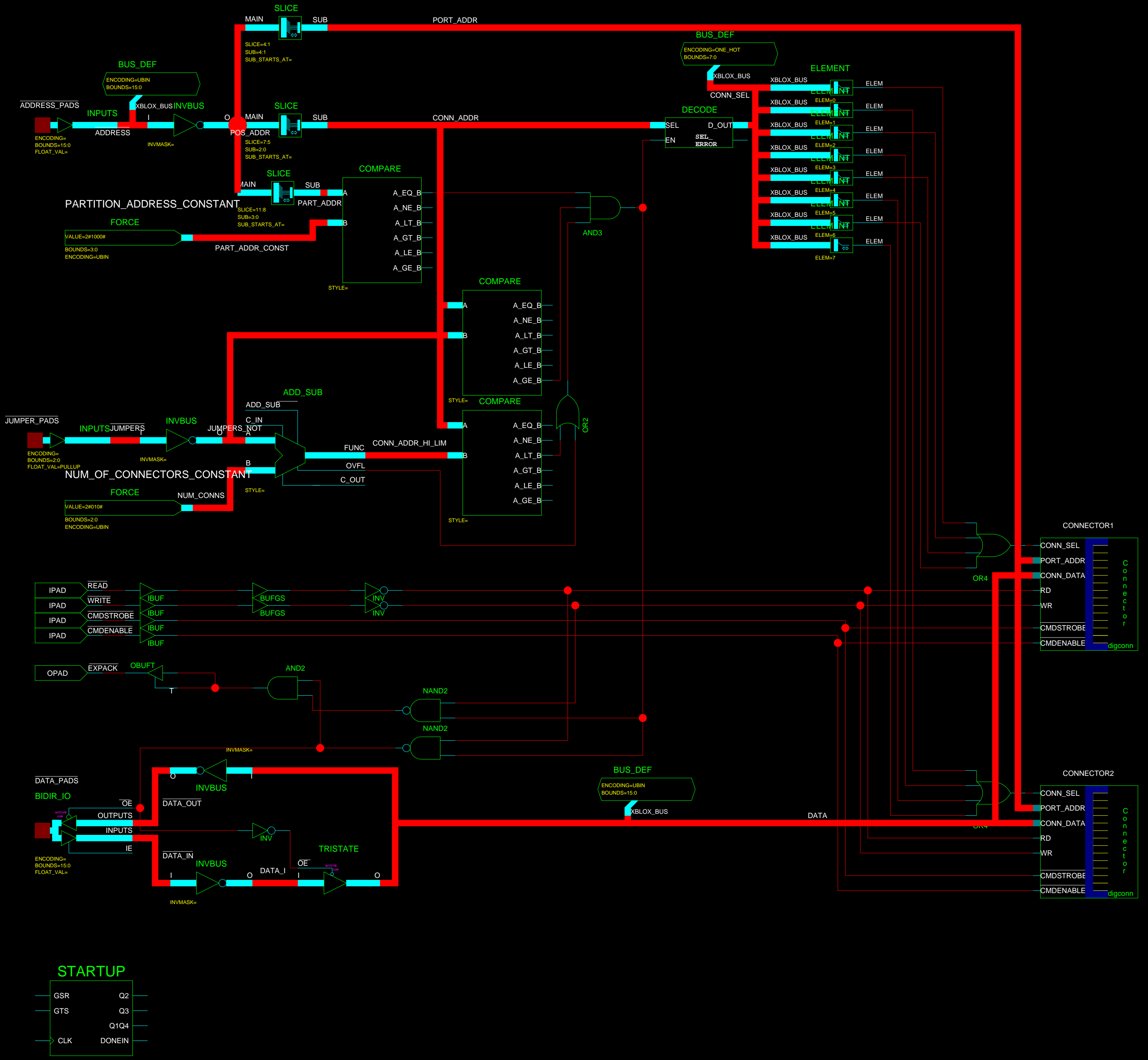

HARVARD UNIVERSITY ATMOSPHERIC RESEARCH PROJECT TITLE		digio.1	
		Digio Xilinx Chip	
PREPARED		size	Code ID No.
CHECKED		Drawing No.	rev
ENGINEER	eil		A
CSHEET			
2-24-2004_14:14		Scale	sheet 1 of 1

Revisions			
Zone	ltr	Description	Approved

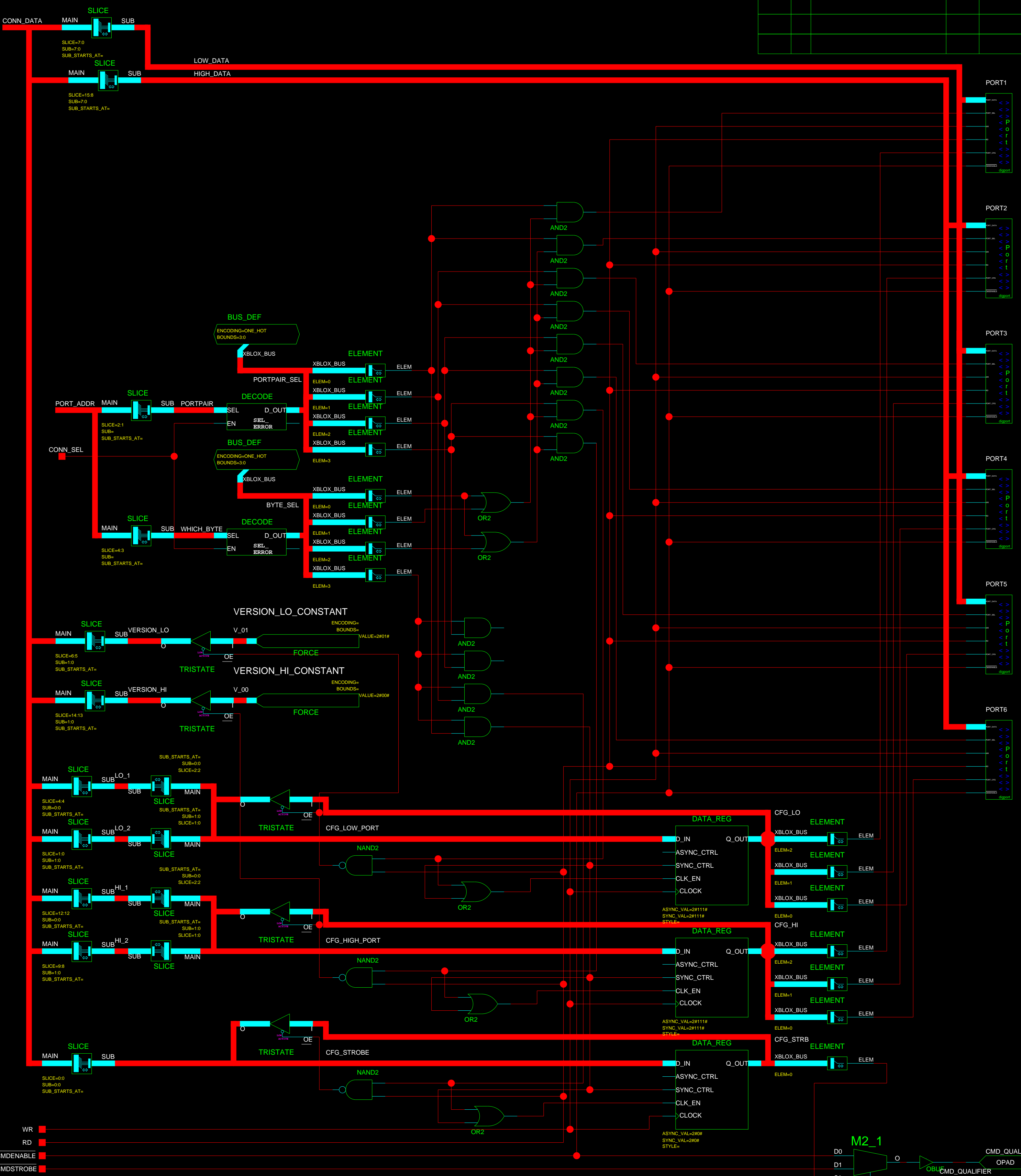

WR
 RD
 CMDENABLE
 CMDSTROBE

HARVARD UNIVERSITY
ATMOSPHERIC RESEARCH PROJECT

TITLE

digconn.1
 Digio Connector part

PREPARED	
CHECKED	
ENGINEER	eil

CSHEET

size	Code ID No.	Drawing No.	rev
C			A

2-24-2004_14:14

Scale

sheet 1 of 1

Revisions			
Zone	ltr	Description	Approved

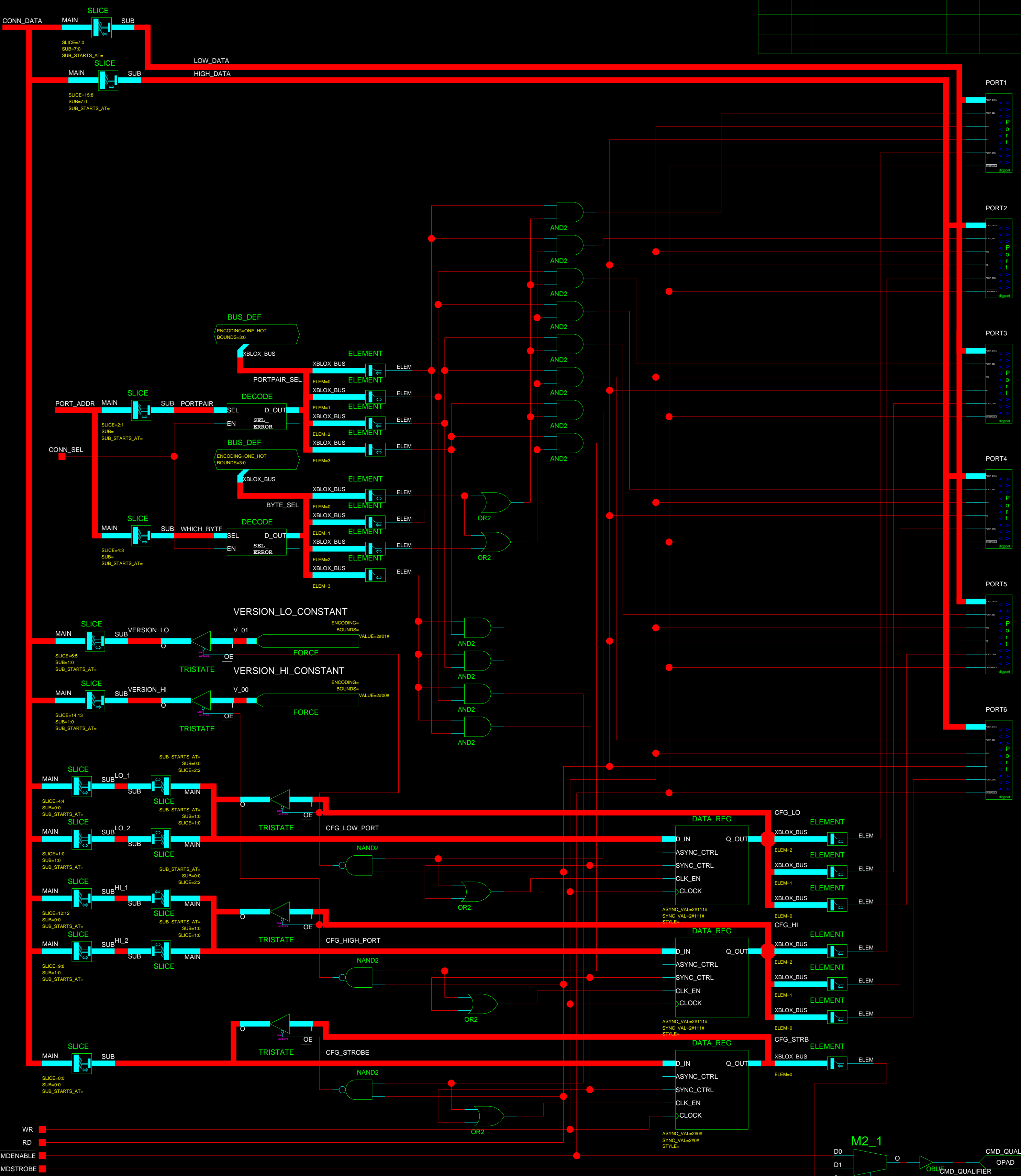

WR
 RD
 CMDENABLE
 CMDSTROBE

HARVARD UNIVERSITY
ATMOSPHERIC RESEARCH PROJECT

TITLE
 digconn.1
 Digio Connector part

PREPARED
 CHECKED
 ENGINEER eil

CSHEET
 2-24-2004_14:14

size	Code ID No.	Drawing No.	rev
C			A

Scale sheet 1 of 1

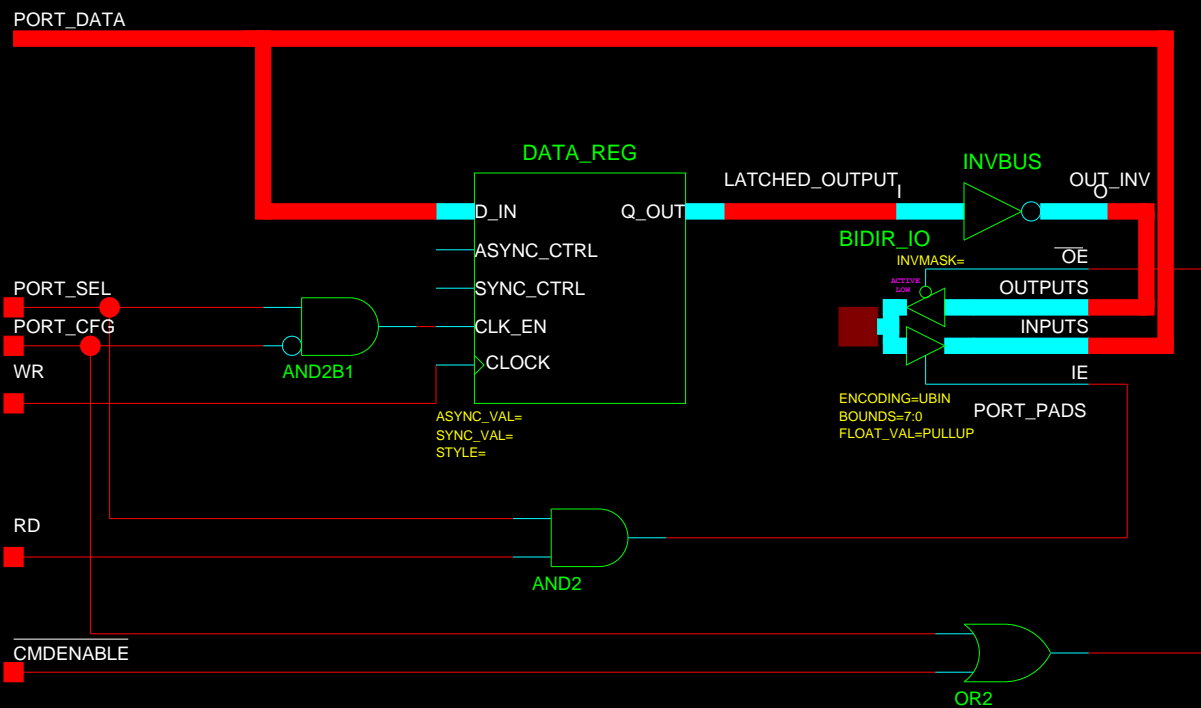

HARVARD UNIVERSITY
ATMOSPHERIC RESEARCH PROJECT

PREPARED		TITLE	
CHECKED		digport.1	
ENGINEER eil		Digio Port Part	
ASHEET		size	Code ID No.
4-20-2005_16:20		A	
		Drawing No.	rev
			A
		Scale	sheet 1 of 1

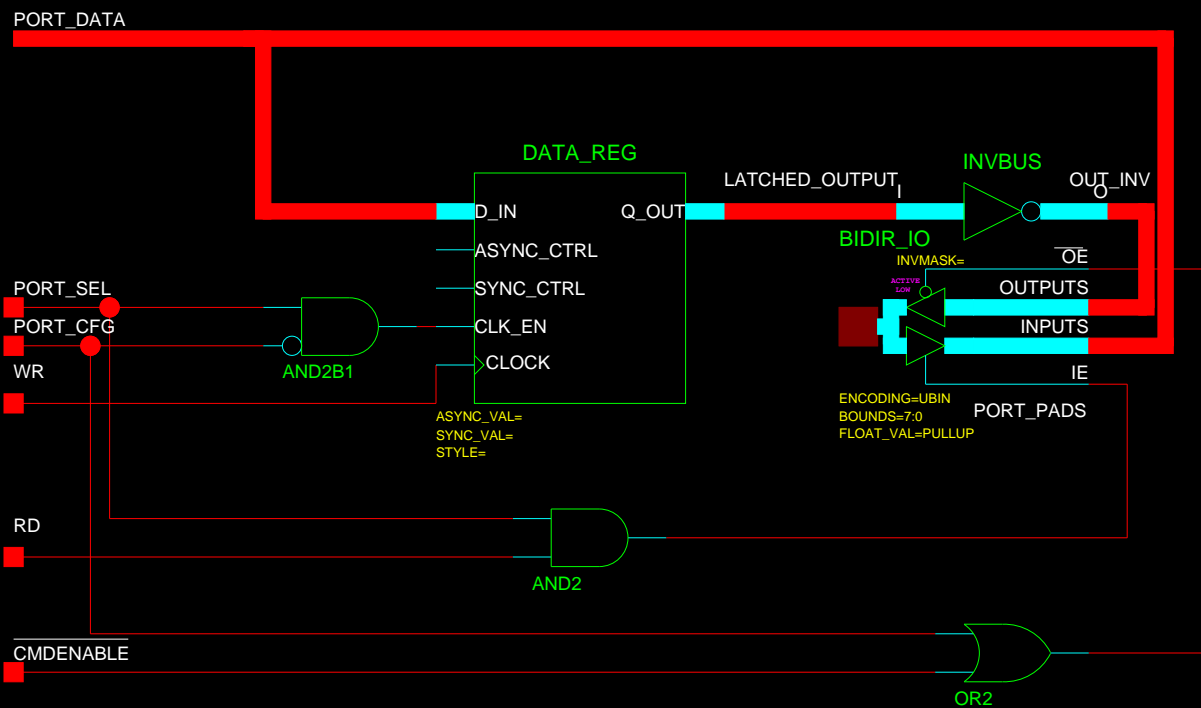

HARVARD UNIVERSITY
ATMOSPHERIC RESEARCH PROJECT

PREPARED		TITLE	
CHECKED		digport.1 Digio Port Part	
ENGINEER eil			
ASHEET		size	Code ID No.
4-20-2005_16:20		A	Drawing No.
		Scale	rev A
		sheet 1 of 1	

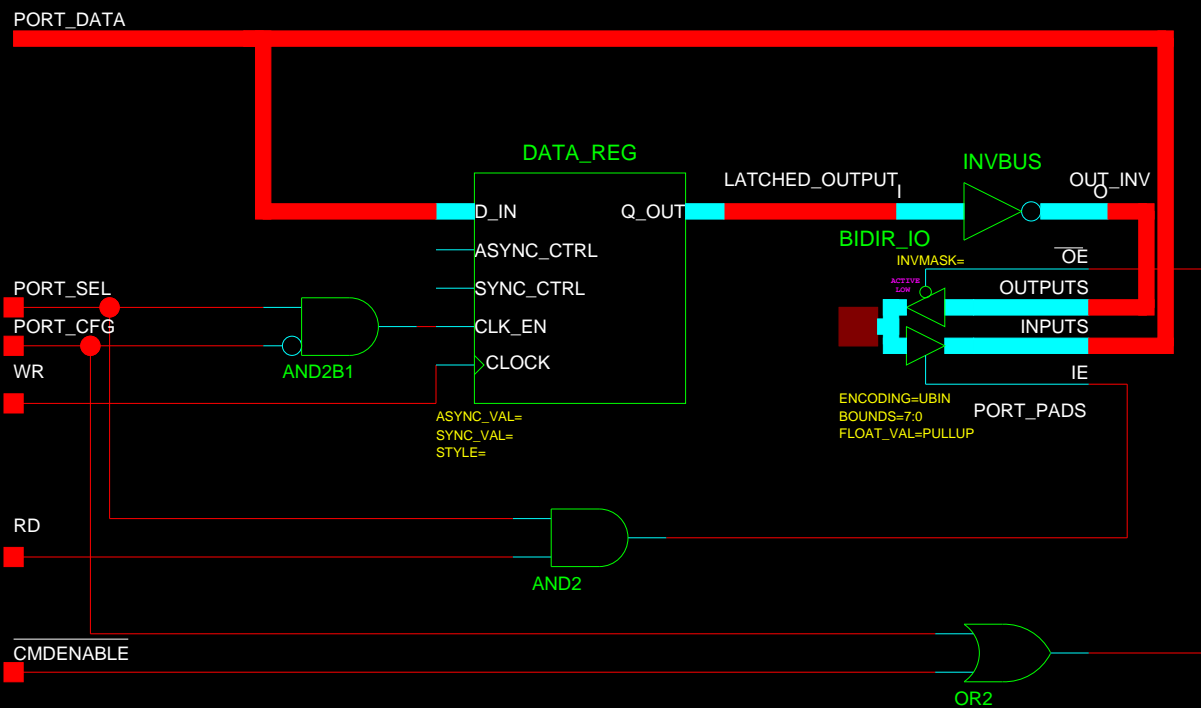

HARVARD UNIVERSITY
ATMOSPHERIC RESEARCH PROJECT

PREPARED		TITLE	
CHECKED		digport.1 Digio Port Part	
ENGINEER eil			
ASHEET		size	Code ID No.
4-20-2005_16:20		A	
		Drawing No.	rev
			A
		Scale	sheet 1 of 1

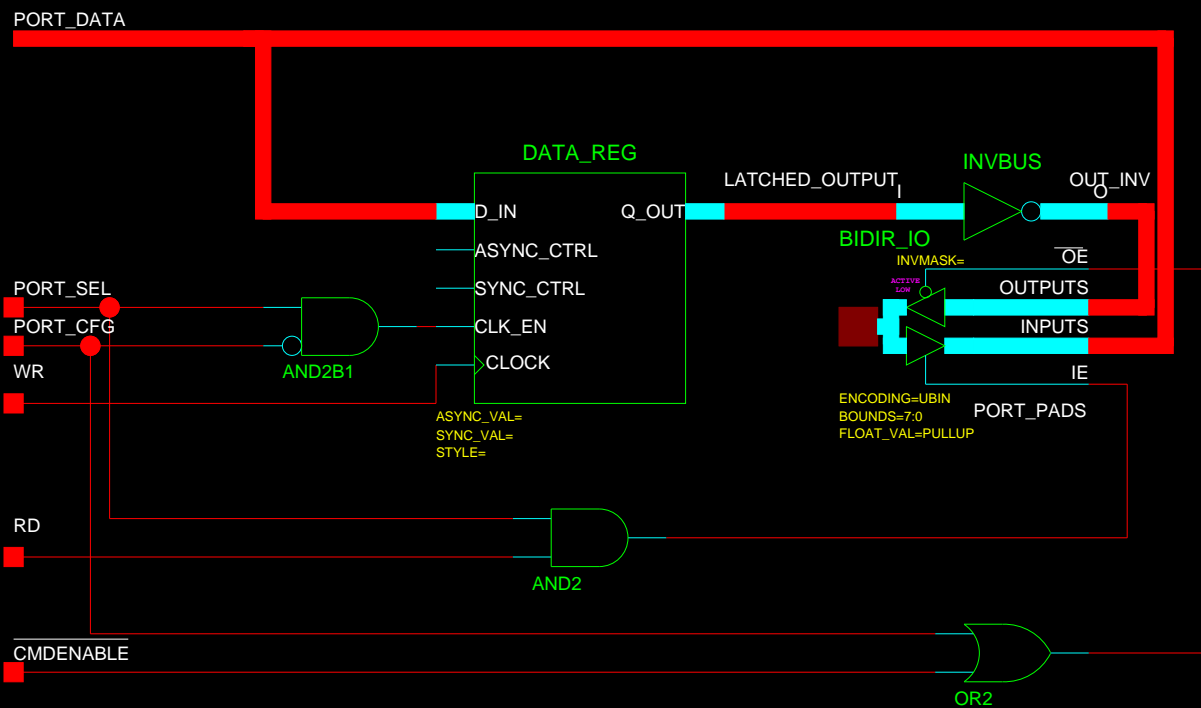

HARVARD UNIVERSITY
ATMOSPHERIC RESEARCH PROJECT

PREPARED		TITLE	
CHECKED		digport.1 Digio Port Part	
ENGINEER eil			
ASHEET		size	Code ID No.
4-20-2005_16:20		A	Drawing No.
		Scale	rev A
		sheet 1 of 1	

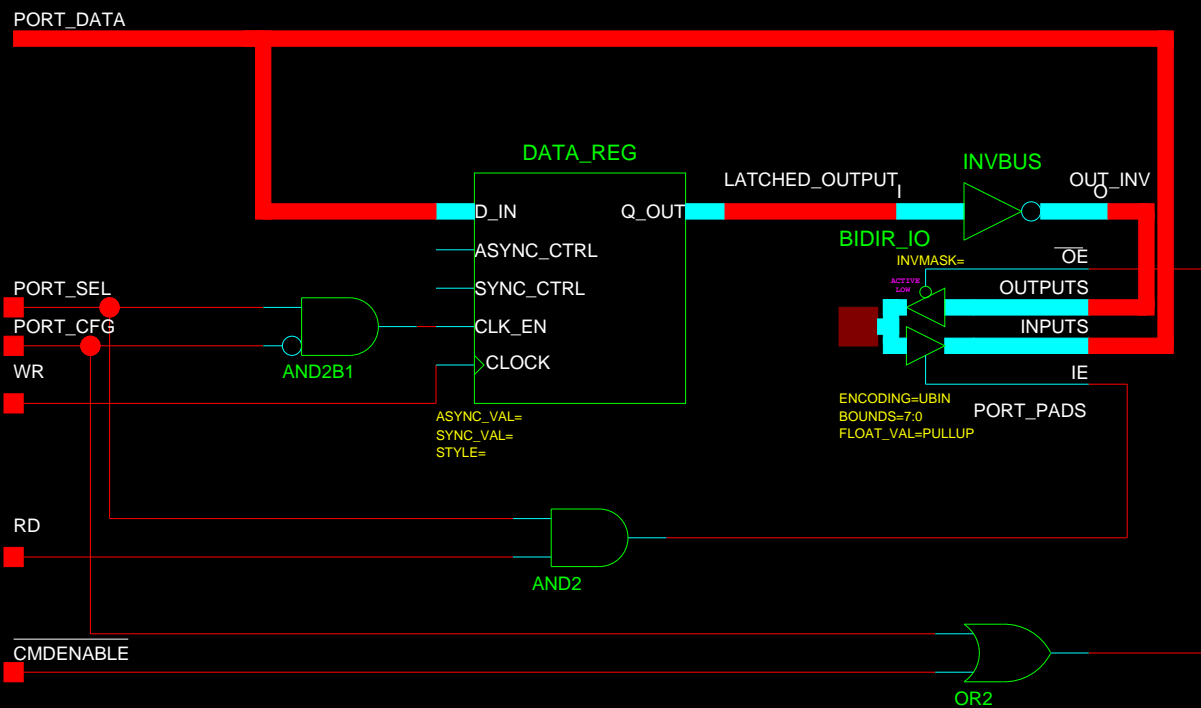

HARVARD UNIVERSITY
ATMOSPHERIC RESEARCH PROJECT

PREPARED		TITLE	
CHECKED		digport.1 Digio Port Part	
ENGINEER eil			
ASHEET		size	Code ID No.
4-20-2005_16:20		A	Drawing No.
		Scale	rev A
		sheet 1 of 1	



Title: XC4000 Family M2_1 Macro

Comments: 2-to-1 Multiplexer

Date: 14th December 1992

Ver: 1

Sheet Size: A

Rev: A

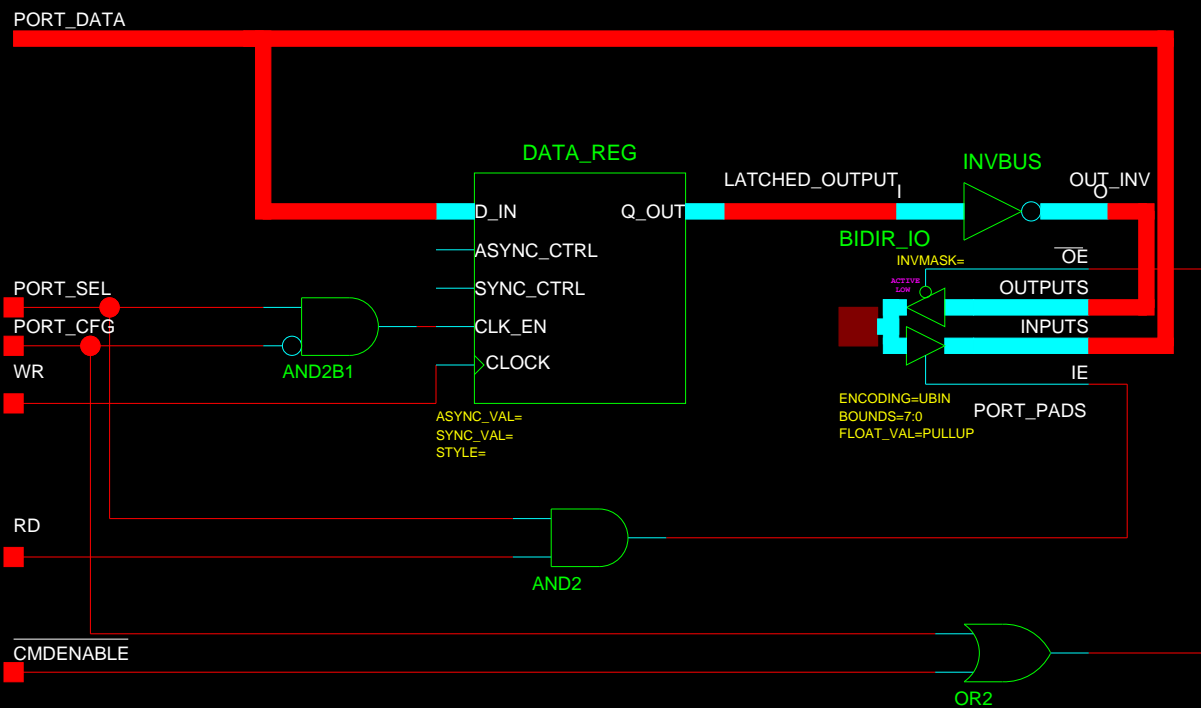

HARVARD UNIVERSITY
ATMOSPHERIC RESEARCH PROJECT

PREPARED		TITLE	
CHECKED		digport.1 Digio Port Part	
ENGINEER eil			
ASHEET		size	Code ID No.
4-20-2005_16:20		A	Drawing No.
		Scale	rev A
		sheet	1 of 1

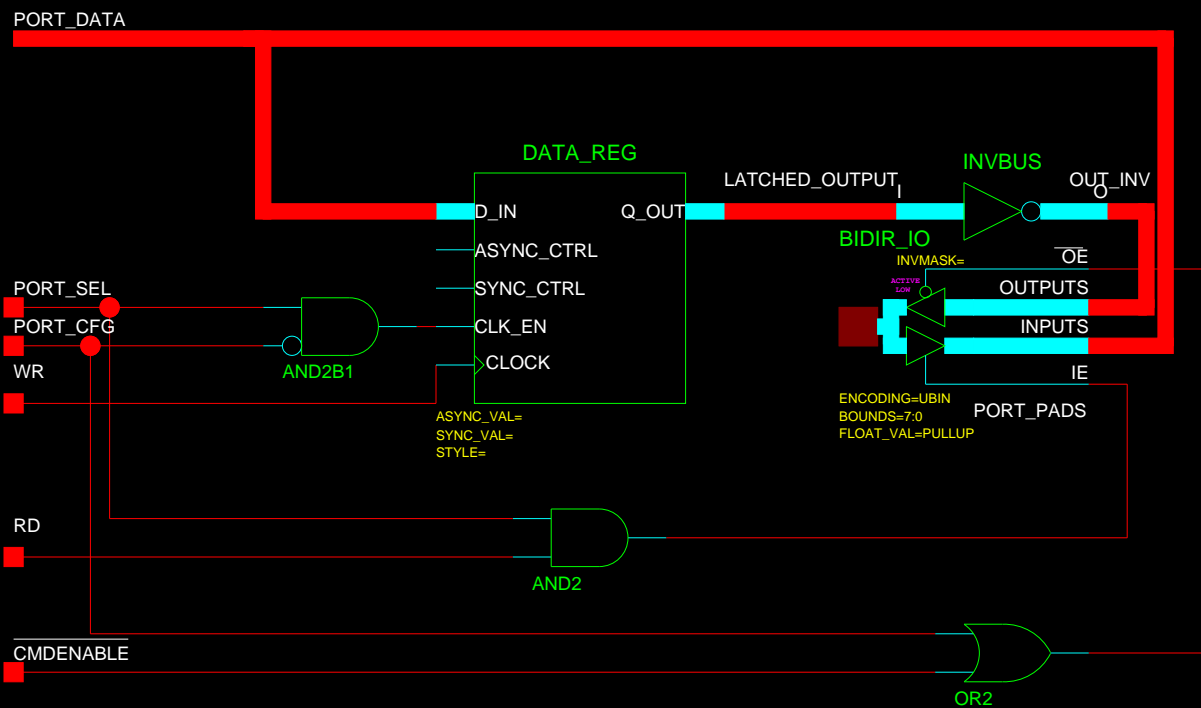

HARVARD UNIVERSITY
ATMOSPHERIC RESEARCH PROJECT

PREPARED		TITLE	
CHECKED		digport.1 Digio Port Part	
ENGINEER eil			
ASHEET		size	Code ID No.
4-20-2005_16:20		A	Drawing No.
		Scale	rev A
		sheet 1 of 1	

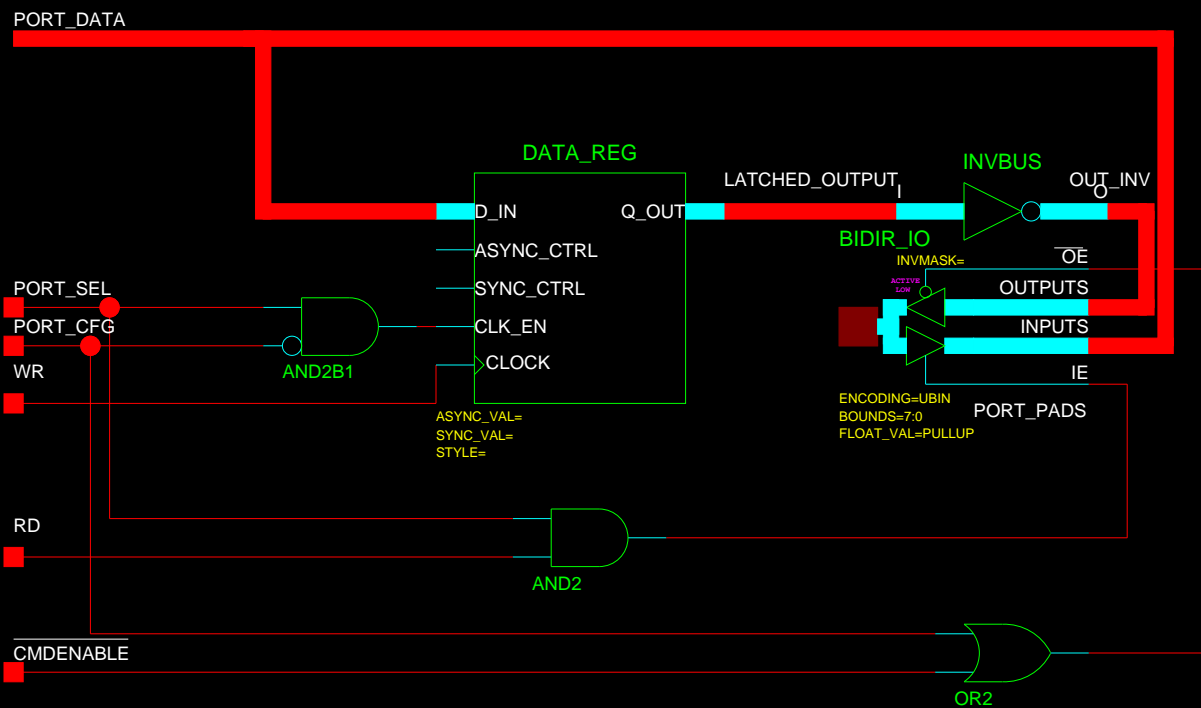

HARVARD UNIVERSITY
ATMOSPHERIC RESEARCH PROJECT

PREPARED		TITLE	
CHECKED		digport.1 Digio Port Part	
ENGINEER eil			
ASHEET		size	Code ID No.
4-20-2005_16:20		A	Drawing No.
		Scale	rev A
		sheet 1 of 1	

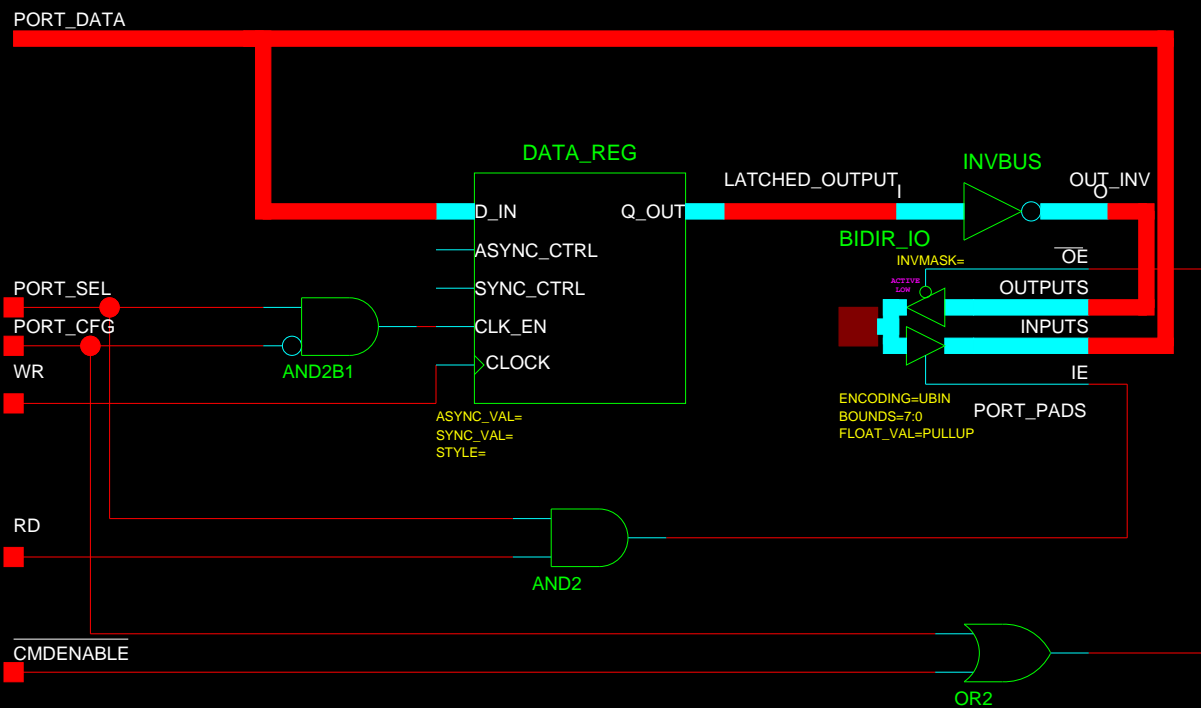

HARVARD UNIVERSITY
ATMOSPHERIC RESEARCH PROJECT

PREPARED		TITLE	
CHECKED		digport.1 Digio Port Part	
ENGINEER eil			
ASHEET		size	Code ID No.
4-20-2005_16:20		A	Drawing No.
		Scale	rev A
		sheet 1 of 1	

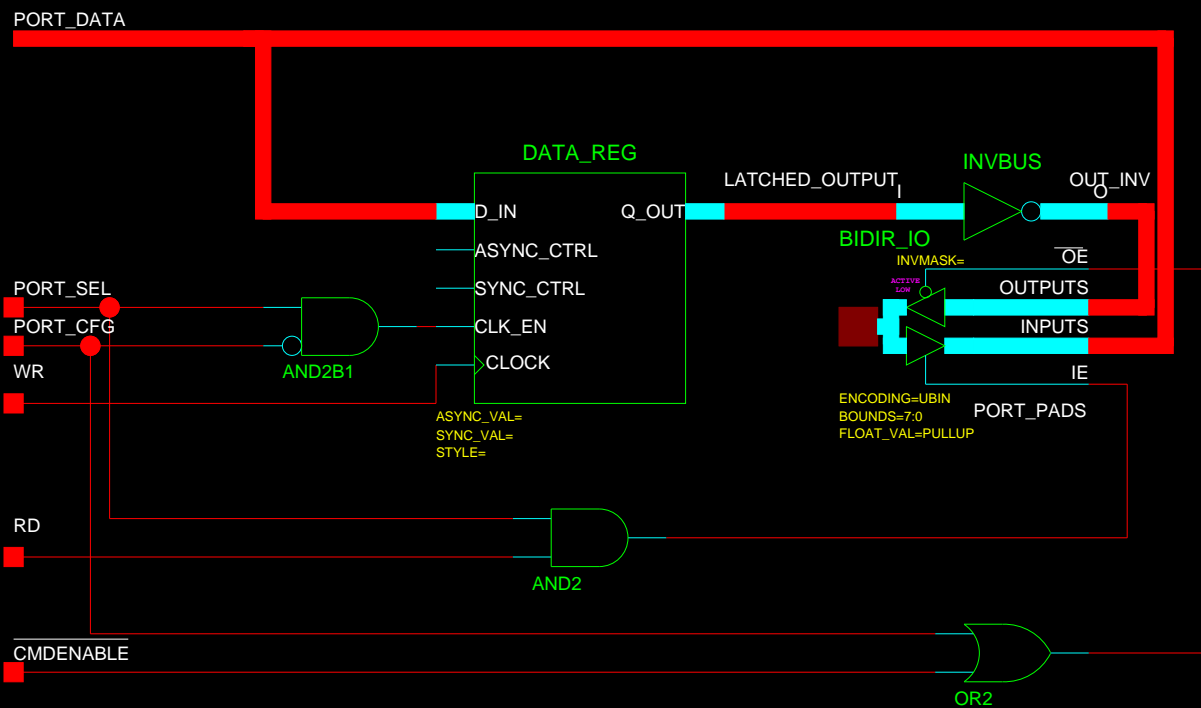

HARVARD UNIVERSITY
ATMOSPHERIC RESEARCH PROJECT

PREPARED		TITLE	
CHECKED		digport.1	
ENGINEER eil		Digio Port Part	
ASHEET		size	Code ID No.
4-20-2005_16:20		A	
		Drawing No.	rev
			A
		sheet	1 of 1



Title: XC4000 Family M2_1 Macro

Comments: 2-to-1 Multiplexer

Date: 14th December 1992

Ver: 1

Sheet Size: A

Rev: A

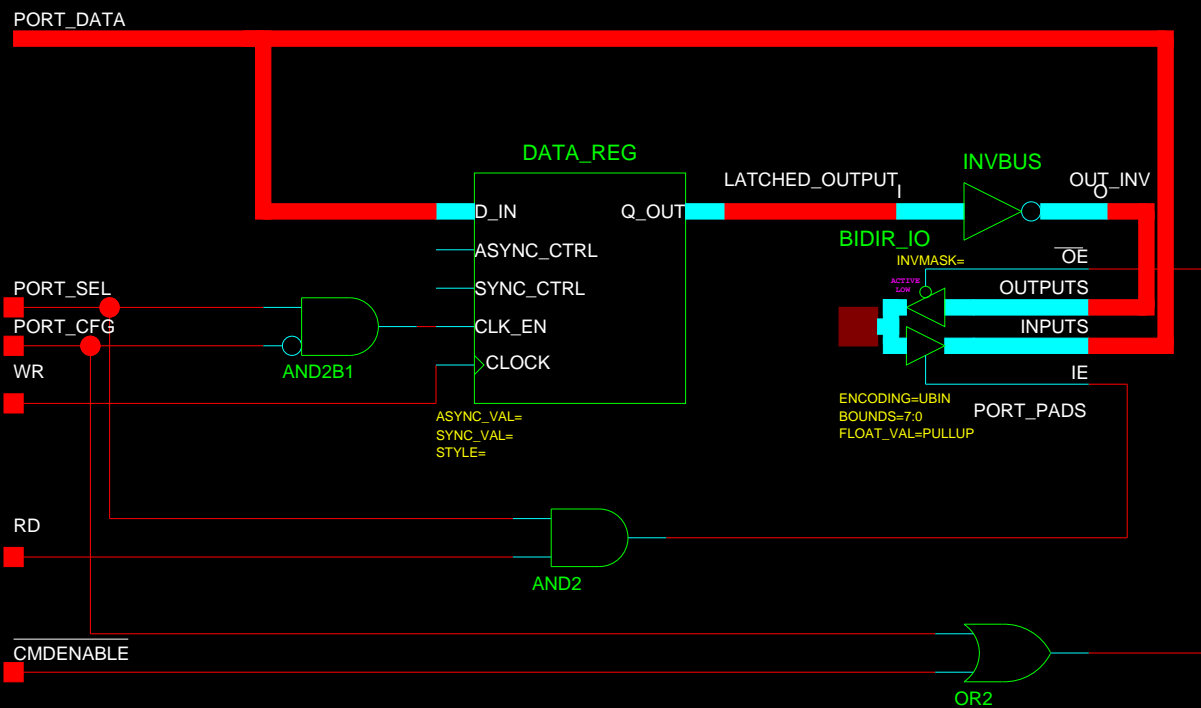

HARVARD UNIVERSITY
ATMOSPHERIC RESEARCH PROJECT

PREPARED		TITLE	
CHECKED		digport.1	
ENGINEER eil		Digio Port Part	
ASHEET		size	Code ID No.
4-20-2005_16:20		A	Drawing No.
		Scale	rev A
		sheet 1 of 1	